



Vacuum Packers Vacuum packer 25m³/h on wheels

ITEM # _____

MODEL # _____

NAME # _____

SIS # _____

AIA # _____



602196 (DVP25A)

Vacuum Packer, 25 m³/h, on wheels

Short Form Specification

Item No. _____

Vacuum packer on wheels, made in 304 AISI stainless steel with domed transparent PMMA Plexiglas lid. Vacuum level control through high-precision sensor. Pressure chamber with rounded corners for easy cleaning. Digital control panel with 10 editable user programs (vacuum, extra vacuum, sealing time, gas percentage). External vacuum in bags or containers possible. Display shows alarm messages if malfunctions are detected (e.g. oil cleaning cycle needed). 3 PE filling plates included. Sealing bar length 455mm. Optional Bluetooth label printer available, for HACCP compliance.

Main Features

- Vacuum packer on wheels with oil lubricated vacuum pump.
- Vacuum level control through high-precision sensor.
- Pressure chamber made of constant thickness, hydroformed, stainless steel with rounded corners for easy cleaning.
- Sturdy, transparent PMMA (plexiglass) lid with rounded edges; opens automatically at the end of the cycle.
- Control panel, resistant to liquids, humidity, dirt and dust.
- 10 editable user programs (vacuum, extra vacuum, sealing time, gas percentage).
- Adjustable sealing time 0.1 to 6 seconds.
- Specific pump oil cleaning cycle (H2Out).
- Automatic warnings if food needs cooling down (hot), failure in the packing process, gas missing, oil change.
- 3 PE filling plates included.
- Sealing bar 455 mm, easily removable for cleaning, with high welding pressure (>200Kg at 99% vacuum).
- With device to lift the removable sealing bar.
- Unit pre-arranged to be connected to an inert gas system.

Construction

- Entirely constructed in 304 AISI stainless steel.
- Free-standing appliance mounted on 4 castors, 2 with brakes.
- Easily accessible oil drain.
- Chromed aluminium die-cast hinges.

Optional Accessories

- Inclined shelf to vacuum liquids, 400mm (for models with 410mm sealing bar or multiples) PNC 650241
- Label printer, bluetooth, for 50x60mm labels, with display in English or Italian PNC 650243

APPROVAL: _____



Vacuum Packers

Vacuum packer 25m³/h on wheels

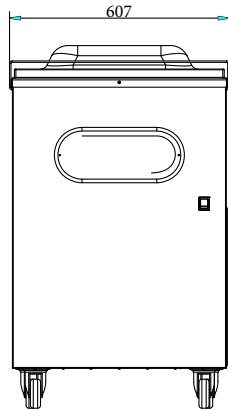

Front

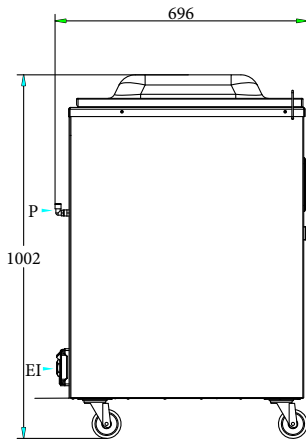

Side

EI = Electrical inlet (power)

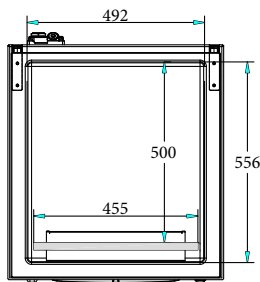

Top

Electric

Supply voltage:

602196 (DVP25A)

220-240 V/1N ph/50-60 Hz

Total Watts:

1.2 kW

Key Information:

Well Capacity:

37.5 lt

Pump:

25 m³/h

Sealing bar position:

Front

Sealing bar length:

455 mm

Max chamber (chamber + cover) dimensions:

556 x 492 x 175 mm

Chamber working dimensions:

500 x 492 x 110 mm

Filling board nr:

3

Gas nozzles:

2

External dimensions, Width:

607 mm

External dimensions, Depth:

696 mm

External dimensions, Height:

1002 mm

Net weight (kg):

115.5

Vacuum Packers
Vacuum packer 25m³/h on wheels

The company reserves the right to make modifications to the products without prior notice. All information correct at time of printing.

2024.04.08

